

EV2M-GOM1

MIPI Fixed Focus Camera Module



Features

- Max. Resolution: 1920 x 1080 @ 30fps
- ISP inside, fisheye De-warping
- Platform Support:
INTEL, Nvidia Jetson, Xilinx
(For more information please contact our local sales)
- Complies with CE/FCC Class A

Resolution	FPS (MIPI 2 lanes)
1920 x 1080 (FHD)	30

Mechanical Drawing

Mechanical Drawing

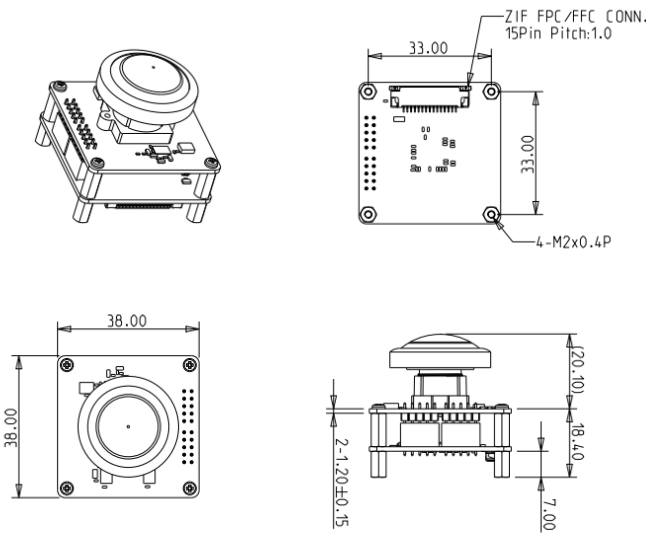

Lens Specification

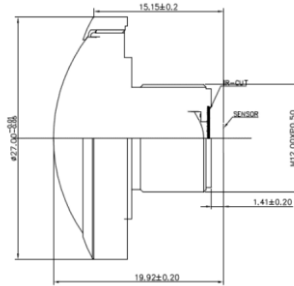

Items	Specification
F no.	2.1
Focal length	1.1mm
Lens structure	4G2P
Mount	M12*P0.5

Headquarters (Taiwan)

5F., No. 237, Sec. 1, Datong Rd.,
Xizhi Dist., New Taipei City 221,
Taiwan
Tel: +886-2-7703-3000
Email: sales@innodisk.com

Branch Offices:

USA
usasales@innodisk.com
+1-510-770-9421

Europe
esusales@innodisk.com
+31-40-3045-400

Japan
jpsales@innodisk.com
+81-3-6667-0161

China
sales_cn@innodisk.com
+86-755-2167-3689

www.innodisk.com

© 2019 Innodisk Corporation.
All right reserved. Specifications
are subject to change without
prior notice.

January 24, 2024

Specifications







Max. Resolution	1920 x 1080 (2MP)@ 30fps
Output I/F	MIPI 15pins (2 lanes)
Power Consumption	Approximate 1.6W
Dimension (WxLxH)	38 x 38 x 45mm
Operating Temp.	-30°C ~ +70°C (main chip spec.)
CMOS Sensor	ONSEMI AR0330
Sensor Size	1/3"
Pixel Size	2.2um
Lens Type	Fixed focus (M12)
Lens FOV	230°
Platform Support	INTEL, Nvidia Jetson, Xilinx (For more information please contact our local sales)

15 Pin #	15 Pin Name	Usage/Description
1	GND	Ground
2	CAM_D0_N	CSI Data 0
3	CAM_D0_P	CSI Data 0
4	GND	Ground
5	CAM_D1_N	CSI Data 1
6	CAM_D1_P	CSI Data 1
7	GND	Ground
8	CAM_CK_N	CSI Clock
9	CAM_CK_P	CSI Clock
10	GND	Ground
11	CAM_PWDN	Camera Power-down
12	CAM_MCLK	Camera Master Clock
13	CAM_SCL	I2C Clock (3.3V)
14	CAM_SDA	I2C Data (3.3V)
15	CAM_3V3	+3.3V

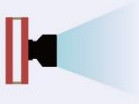
Order information

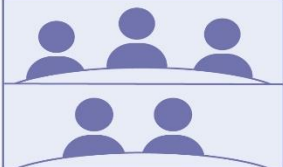
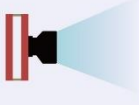
EV2M-GOM1-MUCA-C1
MIPI Fixed Focus Camera Module

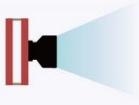
Several modes to fulfill different applications.

Mode	User Scenarios	Image Acquisition
Fish-eye mode (with no calibration)		
Fish-eye Calibration mode		
HFOV 90 degreemode		
HFOV 180 degree mode		

Headquarters (Taiwan)

5F., No. 237, Sec. 1, Datong Rd.,
Xizhi Dist., New Taipei City 221,
Taiwan
Tel: +886-2-7703-3000
Email: sales@innodisk.com

Branch Offices:

USA

usasales@innodisk.com
+1-510-770-9421

Europe

eusales@innodisk.com
+31-40-3045-400

Japan

jpsales@innodisk.com
+81-3-6667-0161

China

sales_cn@innodisk.com
+86-755-2167-3689

www.innodisk.com

© 2019 Innodisk Corporation.
All right reserved. Specifications
are subject to change without
prior notice.

January 24, 2024

Platform	Camera Driver status
Intel® Gen 12 th ADL-N	Support Linux
Intel® Gen 13 th RPL-P	Support Linux
Intel® Core™ Ultra processor MTL-U/H & MTL-PS	Support Linux
Nvidia Jetson NANO/Xavier NX	Support
Nvidia Jetson ORIN NANO/ORIN NX	Support
Xilinx KV260	Support PetaLinux